

STIFFENER REQUIREMENTS IN STIFFENED STEEL PLATE SHEAR WALLS

Ahmad RAHMZADEH

*Earthquake Engineering Graduate Student, School of Civil Engineering,
College of Engineering, University of Tehran, Tehran, Iran
a.rahmzadeh@ut.ac.ir*

Mehdi GHASSEMIEH

*Associate Professor, School of Civil Engineering, College of Engineering, University of Tehran, Tehran, Iran
mghassem@ut.ac.ir*

Keywords: Plate Buckling, Critical Shear Stress, Stiffener, Rigidity, Steel Plate Shear Wall

ABSTRACT

The 6-story Olive View Medical Center in California and the 35-story Kobe City Hall tower, both of which showed good performance while withstanding earthquakes, are two examples of structures that were constructed using stiffened steel plate shear walls as a lateral load resisting system. Stiffeners are used in such lateral load resisting systems to improve the buckling stability of the shear panel. However, using plate girder equations often leads to uneconomical and, in some cases, incorrect design of stiffeners due to major differences between plate girders and steel plate shear walls (SPSWs). In this paper, the effect of the rigidity and arrangement of stiffeners on the buckling behavior of plates is studied using the finite element method (FEM). Subsequently figures covering curves for the design of stiffeners in various practical configurations are presented.

INTRODUCTION

A steel plate shear wall (SPSW) is made of an infill steel plate surrounded by horizontal boundary elements (beams) and vertical boundary elements (columns). It is a relatively new lateral load resisting system, and over the last three decades, because of its excellent performance, has attracted designers' attention in areas of high seismicity. Some of the features of the SPSW system are its high initial stiffness, excellent ductility, robust resistance to cyclic degradation and significant energy dissipation.

SPSWs were first used, along with stiffeners, in the 1970's, since out-of-plane buckling of infill panel was considered at design limitation. Laboratory tests, conducted by Takahashi et al. (1973), on plates with various thicknesses and different stiffener dimensions, indicated that by effectively reinforcing the shear panel using stiffeners, hysteresis loops of an SPSW can be transformed from s-shaped in the thin SPSW to spindle-shaped in the stiffened SPSW as shown in Fig. 1. This transformation increases the area under the hysteresis loops, which increases the energy dissipation of the wall and simultaneously improves its performance. Some distinguished practical uses of this system are as follows: a 20-story office building in Tokyo, Japan (Thorburn et al., 1983); a 53-story high rise in Tokyo, Japan (Astaneh-Asl, 2001); a 30-story hotel in Dallas, Texas (Astaneh-Asl, 2001); a 6-story hospital in Los Angeles, California (Astaneh-Asl, 2001); and a 35-story office building in Kobe, Japan (Astaneh-Asl, 2001).

After the construction of the last two buildings was completed, they were exposed to the 1994 Northridge and the 1995 Kobe earthquakes respectively. Both buildings performed well during the earthquakes, and only experienced minor structural damages (Naeim and Lobo, 1994; Fujitani et al., 1996). Current design specifications (AISC 341-10; Sabelli and Bruneau, 2007) have not properly addressed the issue of stiffened SPSW, and because the boundary elements in an SPSW are different from those in a plate

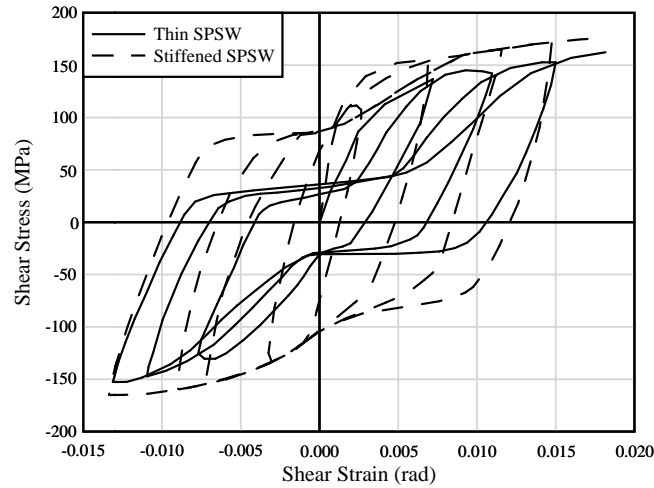

Fig. 1. Hysteresis curves in thin and stiffened SPSWs (Takahashi et al., 1973).

girder, the equations used for the plate girders cannot be assigned to SPSWs (Berman and Bruneau, 2004). In this paper, using analytical study and finite element method (FEM), the effect of stiffeners on the out-of-plane buckling behavior of infill panel of an SPSW is investigated.

THEORETICAL STUDY ON BUCKLING STRESS

Since one of the principal stresses in an SPSW is compressive, in order to prevent early elastic buckling, the buckling strength of the infill panel must be inspected.

Elastic Buckling of Rectangular Plates in Shear

At the onset of the buckling of a plate, when the flat form of equilibrium becomes unstable, the energy method can be used to calculate the critical values of forces applied in the middle plane of the plate. The energy method used in this case is because it has proven to be an excellent tool in solving a problem that cannot be solved directly as a characteristic value problem, such as stiffened plates (Timoshenko, 1936). For a given plate of length L , height h and thickness t , subjected to uniformly distributed shear stress along the edges (Fig. 2), by using the principle of stationary potential energy, one gets:

$$V + T = \text{Constant} \quad (1)$$

in which V is the strain energy of bending of the plate and T is the change of potential energy of the external forces when the plate passes from its plane form to the deflected shape (which is equal to the negative value of the work performed by the uniformly distributed shear stress). V and T are expressed by the following:

$$V = \frac{D}{2} \int_0^L \int_0^h \left\{ \left(\frac{\partial^2 w}{\partial x^2} + \frac{\partial^2 w}{\partial y^2} \right)^2 - 2(1-\epsilon) \left[\frac{\partial^2 w}{\partial x^2} \frac{\partial^2 w}{\partial y^2} - \left(\frac{\partial^2 w}{\partial x \partial y} \right)^2 \right] \right\} dx dy \quad (2)$$

$$T = -\int_0^L \int_0^h t \frac{\partial w}{\partial x} \frac{\partial w}{\partial y} dx dy \quad (3)$$

where, $D = Et^3/12(1-\epsilon^2)$ is the flexural rigidity of the plate, E is the Young's modulus, ϵ is the Poisson's ratio and w is the deflection of the plate in the state of buckling. In the case of reinforcing the plate by stiffeners, internal energy of bending of stiffeners should be added into Equation (1).



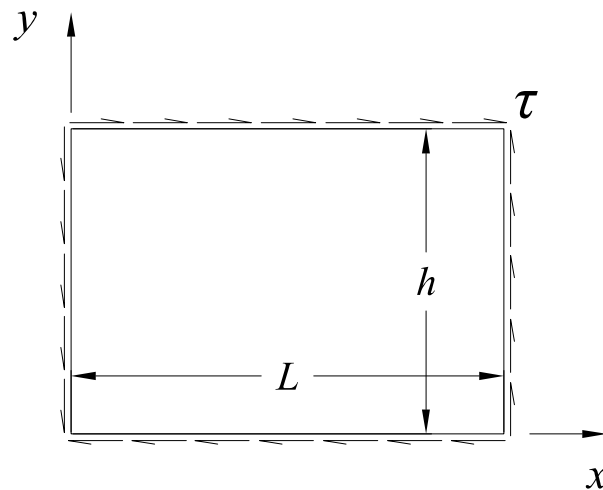

Fig. 2. A rectangular plate subjected to uniformly distributed shear stress in its middle plane.

By assuming an expression for w , which satisfies boundary conditions, and substituting it into Equations (1)-(3), one arrives at the typical form of the expression for the critical stress of rectangular plates, i.e.,

$$\tau_{cr} = k_s \frac{f^2 E}{12(1-\epsilon^2)} \left(\frac{t}{h} \right)^2 \quad (4)$$

where k_s is the critical shear stress coefficient which is a function of boundary conditions and the plate aspect ratio. It should be noticed that the value of k_s is approximate, and its accuracy depends on the assumed expression of w . The following equation has been used to produce a parabolic curve, for simply supported edges, to approximate values of k_s for different properties of plates:

$$k_s = 5.34 + 4 \left(\frac{h}{L} \right)^2 \quad \text{for } h \leq L \quad (5)$$

Elastic Buckling of Plates Reinforced by Transverse Stiffeners in Shear

Equation (4) indicates that the ratio of the plate's thickness to its smaller dimension has a remarkable influence on the critical stress of the plate in shear. If a plate is subdivided by sufficiently rigid stiffeners, smaller panels are formed, which may be considered as simply supported. Therefore, the decisive thickness-to-width ratio can be noticeably increased, and, consequently, the critical stress can be increased as well, due to its being proportional to the square of this ratio.

Using the non-dimensional parameter $\beta = EI/Dd$, in which I is the moment of inertia of the stiffener, d is the stiffener spacing, and the energy method as before, it can be proved that the inclined waves of the buckled plate run across the stiffener if the rigidity of the stiffener is not sufficient. This case is also known as global buckling mode. By subsequently increasing β , the buckling pattern of the stiffened plate changes, and we reach a limiting value of β_0 , which ensures that the stiffeners remain straight. This is known as local buckling mode. A further increase of β , practically, does not add to the buckling strength of the reinforced plate. When reinforced by stiffeners having a ratio of β_0 , each plate panel can be considered as a simply supported plate in shear, and the critical stress reaches its maximum value.

Having used a more suitable buckling configuration w , Stein and Fralich (1949) improved Timoshenko's method for plates reinforced by equidistant transverse stiffeners of equal flexural rigidity (Fig. 3). They also presented curves to obtain the value of k_s for practical subpanel aspect ratios of 1, 2 and 5 (Figures 4-6). As is illustrated in these figures, it is only when rigidity of the stiffeners is low and they are placed with little distance from each other that the plate can be assumed orthotropic. On the other hand, the assumption of simply supported panels for high rigidities of stiffeners seems to be fairly conservative, due to overlooking the continuity of plate across the stiffeners (Stein and Fralich, 1949).

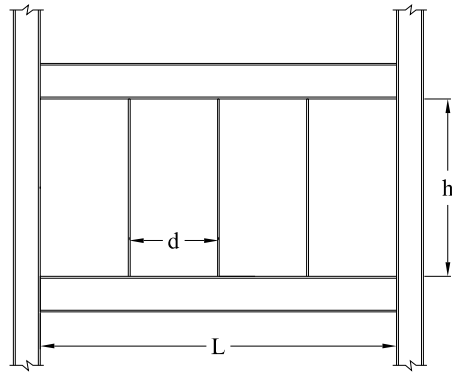

Fig. 3. Steel plate shear wall with vertical stiffeners

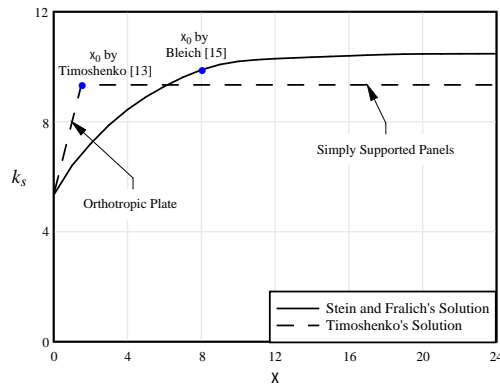

Fig. 4. Critical shear stress coefficient for plates with transverse stiffeners and subpanel aspect ratio of 1 (Stein and Fralich, 1949).

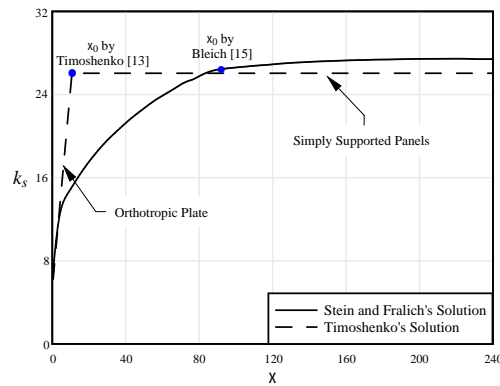

Fig. 5. Critical shear stress coefficient for plates with transverse stiffeners and subpanel aspect ratio of 2 (Stein and Fralich, 1949).

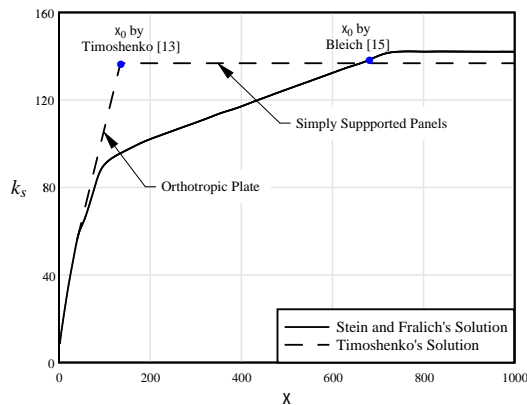

Fig. 6. Critical shear stress coefficient for plates with transverse stiffeners and subpanel aspect ratio of 5 (Stein and Fralich, 1949).



Based on the above curves, Bleich (1952) suggested the following equation for calculating the limiting value of τ_0 ,

$$x_0 = 4 \left\{ 7 \left(\frac{h}{d} \right)^2 - 5 \right\} \quad \text{for } d \leq h \quad (6)$$

Elastic Buckling of Plates Reinforced by Longitudinal and Transverse Stiffeners in Shear

Fig. 7 depicts the general configuration of plates reinforced by longitudinal and transverse stiffeners in shear. By defining α_p as the panel aspect ratio and α_s as the subpanel aspect ratio, it can be found that when buckling occurs in subpanels, for a constant value of α_s , α_p does not have any influence on k_s . On the other hand, from Equation (5) and Figures 4-6, it can be concluded that when subpanels are square, i.e. $b = d$, k_{cr} reaches its maximum value.

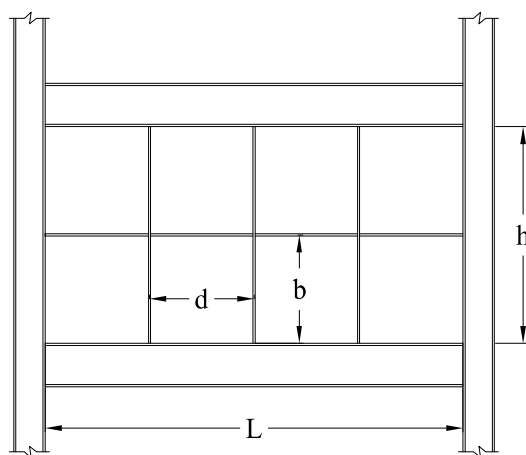

Fig. 7. Steel plate shear wall with vertical and horizontal stiffeners.

By defining α_s as the ratio of the panel's height to the stiffener spacing and using finite element analysis (FEA), the following curves are obtained, and presented in Fig. 8, to evaluate k_s for practical values of α_s for plates reinforced by longitudinal and transverse stiffeners of equal flexural rigidity with square subpanels. It should be noted that for the global buckling range of each curve, average values have been used.

Unlike plate girders, the only goal for stiffened SPSWs is for the infill panel to have a shear yielding. Due to the existence of strong boundary elements, there is no persistence on the stiffeners to remain straight up to the ultimate capacity of the infill panel. When the designer requires the stiffener to remain straight up to the ultimate capacity, the use of the subpanel aspect ratio in Equation (6) (Line A in Fig. 8) is not valid, and the value of x_0 in Equation (6) (Line B in Fig. 8) can be used conservatively, in order to evaluate the limiting value of τ_0 .

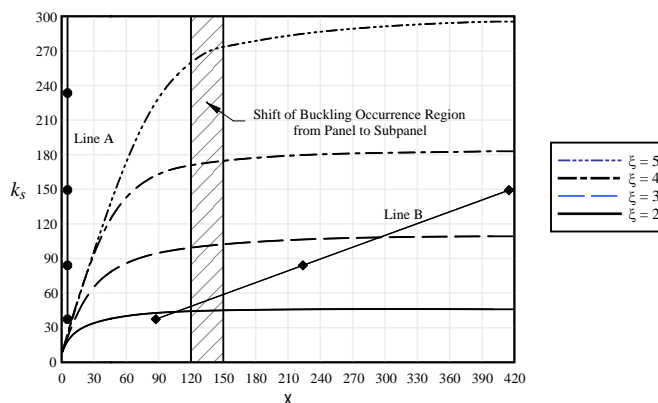

Fig. 8. Critical shear stress coefficient for plates with longitudinal and transverse stiffeners and square subpanels.

The curves presented in Figures 4-6 and 8 are only valid for stiffeners with negligible torsional rigidity. For the infill panel to yield in shear, the following requirement should be met:

$$\tau_{cr} = k_s \frac{f^2 E}{12(1-\nu^2)} \left(\frac{t}{h} \right)^2 \geq \tau_y \rightarrow k_s t^2 \geq 0.6388 \frac{h^2 \tau_y}{E} \quad (7)$$

in which $\tau_y = \frac{f_y}{\sqrt{3}}$ is the shear yield stress, τ_y the specified minimum yield stress, and k_s can be obtained from Figures 4-6 and 8 for different configurations of stiffened SPSWs.

CONCLUSIONS

In this study, the characteristics of the stiffeners on the steel plate shear wall is investigated. By stiffening a thin SPSW, its critical shear stress increases. The increase in the buckling capacity of the SPSW depends on the rigidity and arrangement of the stiffeners. The use of orthotropic plate solution to calculate the buckling stress of stiffened plates in shear may be considered without error for only a limited number of cases. As illustrated in Figures 4-6 and 8, curves have been introduced to estimate the critical shear stress coefficient for various practical configurations of stiffeners.

REFERENCES

- AISC, ANSI/AISC 341-10, 2010. *Seismic Provisions for Structural Steel Buildings*. Chicago: American Institute of Steel Construction.
- Astaneh-AslA(2001)*Seismic Behavior and Design of Steel Shear Walls*. Steel Technical Information and Product Services Report. Moraga, CA: Structural Steel Educational Council
- Berman JW and Bruneau M(2004) Steel Plate Shear Walls Are Not Plate Girders. *AISC Engineering Journal*, 41(3), pp.95-106
- Bleich F(1952)*Buckling Strength of Metal Structures*. New York: McGraw Hill.
- Fujitani H et al.(1996) Damage and Performance of Tall Buildings in The 1995 Hyogoken Nanbu Earthquake. In *Proceedings of 67th Regional Conference (in conjunction with ASCE Structures Congress XIV)*. Chicago, 1996. Council on Tall Building and Urban Habitat
- Naeim F and Lobo R(1994) Performance of Nonstructural Components During the January 17,1994 Northridge Earthquake: Case Studies of Six Instrumented Multistory Buildings. In *Proceedings of the ATC-29-1 ATC-29-1 Seminar on Seismic Design, Retrofit, and Performance of Nonstructural Components*. Redwood City, CA, 1994. Applied Technology Council
- Sabelli R and Bruneau M(2007)*Design Guide 20: Steel Plate Shear Walls*. Chicago: American Institute of Steel Construction
- Stein M and Fraich RW(1949)*Critical Shear Stress of Infinitely Long, Simply Supported Plate with Transverse Stiffeners*. NACA Technical Note No. 1851
- Takahashi Y, Takeda T, Takemoto Y and Takagi M(1973) Experimental Study on Thin Steel Shear Walls and Particular Steel Bracing under Alternative Horizontal Loads. In *Proceedings, IABSE Symposium, Resistance and Ultimate Deformability of Structures Acted on by Well Defined Repeated Loads*. Lisbon, Portugal, 1973
- Thorburn LJ, Kulak GL and Montgomery CJ(1983)*Analysis of Steel Plate Shear Walls*. Structural Engineering Report No. 107. Edmonton, Alberta: University of Alberta
- Timoshenko S(1936)*Theory of Elastic Stability*. New York: McGraw Hill

