

## **YIELDING-CURVED-BARS & HEMISPHERE CORE ENERGY DISSIPATING DEVICE AS THE CENTRAL SUPPORT OF REPAIRABLE BUILDINGS WITH SEESAW MOTION**

Nooshin GHORBANI AMIRABAD

*Graduate Student, Civil Engineering Department, School of Engineering, South Tehran Branch of Islamic Azad University, Tehran, Iran  
Nooshin.ghorbani.6619@gmail.com*

Mahmood HOSSEINI

*Associate Professor, Civil Engineering Department, School of Engineering, South Tehran Branch of Islamic Azad University, Tehran, Iran  
hosseini@iiees.ac.ir*

**Keywords:** Repairable Buildings, See-Saw Motion, Finite Element Analysis, Hysteretic Behavior

### **ABSTRACT**

Design of repairable buildings, whose structural systems can be easily repaired after a major earthquake, instead of demolishing and rebuilding, have been paid great attention by some researchers in recent decade. In this paper a study in which specific attention has been paid to the behavior of the central support which has a main role in creating the possibility of seesaw motion in the building's structural system, as well as creating some capacity of seismic energy dissipation is presented. The proposed device can be called briefly Yielding Curved Bars (YCB) energy dissipater. The YCB energy dissipater can act as the central support under the central main column of the building at lowest level. The clipped hemisphere carries the vertical load of the central column of the building with seesaw motion, and transfer it directly to its concave bed, while the curved bars around the clipped hemisphere act as yielding elements during the seesaw motion of the building which causes the central column to incline, and this inclination causes the rotation of the YCB device around a horizontal axis, resulting in large plastic deformations of curved rods, and therefore, large amount of energy dissipation during earthquake excitations. The YCB device was modeled by a powerful finite element analysis computer program and its hysteretic behavior under the simultaneous effects of vertical and horizontal loads was obtained. To investigate the efficiency of using the YCB device in reduction of seismic response of buildings a multi-story regular steel building was considered once with conventional design and once equipped with the YCB device and some similar yielding energy dissipaters under all circumferential columns and the seismic responses were calculated by time history analyses, employing a set of selected three-component accelerograms. Results show the high efficiency of the YCB devices in seismic response reduction of buildings.

### **INTRODUCTION**

Design of repairable buildings, i. e. the buildings whose structural systems can be easily repaired after a major earthquake, instead of demolishing and reconstructing, have been paid great attention by some researchers in recent decade. Use of rocking mechanism of the building's structure (Azuhata 2004) and employing telescopic columns in buildings with rocking motion (Hosseini and NoroozinejadFarsangi 2012) are two samples of these researches. More specifically, using a multi-stud energy dissipating device as the central fuse for regular steel buildings with rocking motion (Hosseini and Kherad 2013) can be mentioned as a study in which specific attention has been paid to the behavior of the central support which has a main role in creating the possibility of rocking motion or seesaw motion (to be more precise) in the building's structural system.

Also in recent studies the use of yielding-based energy dissipaters has drawn more attention particularly in regular steel buildings to make them repairable after major earthquakes (Hosseini and Alavi 2014).

In this study a somehow-innovative energy dissipater which can act as the central support of the buildings with seesaw motion, and are repairable after major earthquakes, is introduced. First, the proposed energy dissipating device has modeled by a powerful finite element analysis computer program and its hysteretic behavior under the simultaneous effects of vertical and horizontal loads has been obtained. Then, to investigate the efficiency of using the proposed energy dissipater in reduction of seismic response of buildings' structures, a multi-story regular steel building has been considered once with conventional design and once equipped with the proposed energy dissipating device, and some similar yielding energy dissipaters under all circumferential columns, and the seismic responses have been calculated by time history analyses, employing a set of selected three-component accelerograms. Details of the study are presented briefly in the following section of the paper.

## THE PROPOSED ENERGY DISSIPATING DEVICE

The proposed energy dissipater, which is of the yielding-based type, is consisted of a clipped hemisphere, as the central core for carrying the vertical loads, and some initially curved bars as energy dissipating parts, connecting the clipped hemisphere to its concave bed as shown in Figure 1.

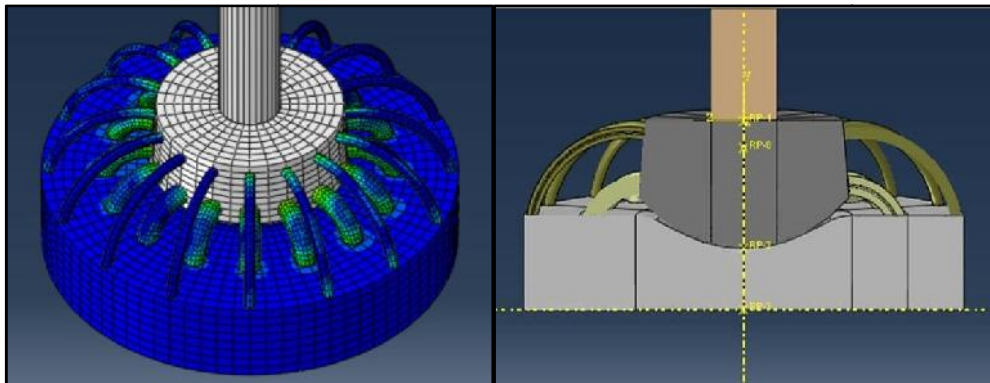

Figure 1. General view and section of the Yielding-Curved-Bars and Clipped Hemisphere Core energy dissipater

Looking at Figure 1, the proposed device can be called Yielding Curved Bars and Clipped Hemisphere Core (YCB&CHC or more briefly YCB) energy dissipater. As it can be understood from Figure 1, the YCB energy dissipater can act as the central support under the central main column of the building at its base lowest level. The clipped hemisphere carries the vertical load of the central column of the building with seesaw motion, and transfers them directly to its concave bed, while the curved bars around the clipped hemisphere act as yielding elements during the seesaw motion of the building which causes the central column to incline, as shown in Figure 2.

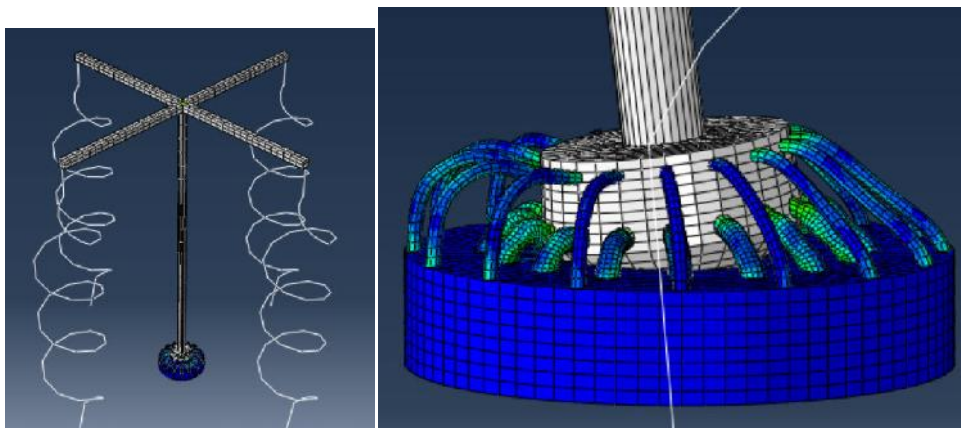

Figure 2. Simplified model of the building's structure with seesaw motion (left) and the plastic deformation of the YCB energy dissipater and central support due to the inclination of the building's central column (right)

As shown in Figure 2, the inclination of the central column of the building cause the rotation of the YCB device around a horizontal axis, resulting in large plastic deformations of the curved rods, and therefore, large amount of energy dissipation during earthquake excitations. The YCB device was modeled in a powerful finite element analysis computer program, and its hysteretic behavior under the simultaneous effects of vertical and horizontal loads was investigated. Figure 3 shows a sample of the moment – rotation hysteretic loops of the YCB device subjected to the cyclic controlled excitation of rotation type with increasing amplitude under a constant vertical load.

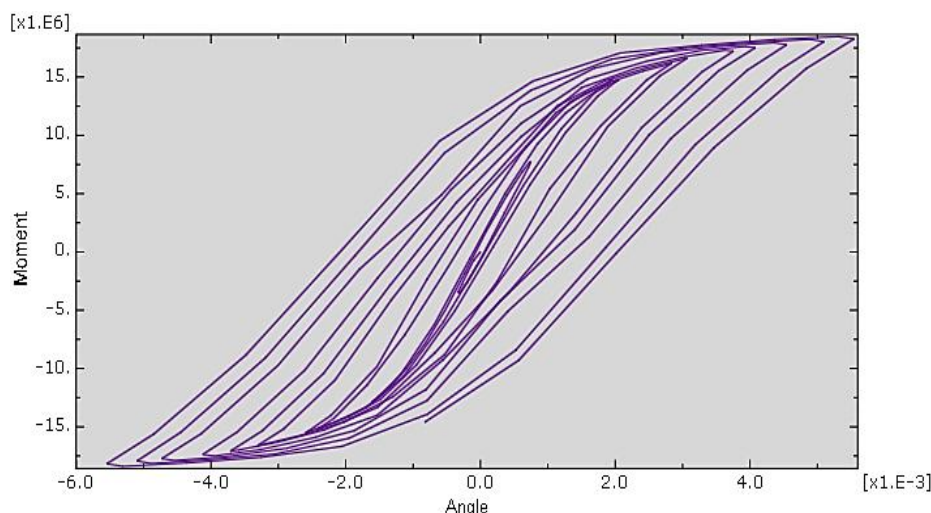

Figure 3. A sample moment-rotation hysteresis of the YCB device (Moment in N.m and Rotation Angle in rad)

It is seen in Figure 3 that the hysteresis loops of the YCB device are quite stable and no pinching effects is observed. The backbone curve of the hysteretic behavior of the YCB device can be easily obtained from the hysteretic curves and is used for introducing device to the structural analysis program as a multi-linear plastic link for modeling the device in the overall structural model of the building with seesaw motion as explained in the next section.

## USING THE YCB DEVICE IN MULTISTORY BUILDINGS

To investigate the effect of using YCB device in reducing the seismic response of buildings it was used as the central support and fuse in a few multistory regular steel buildings. The results related to the 12-story building are presented here in brief, and the results related to other studied buildings can be found in the main report of the study (Ghorbani Amirabad 2015). In case of the 12-story building with seesaw motion (called from now on 'seesaw building' for brevity) of which the results are presented here, the specifications of the multi-linear plastic link considered for the YCB central fuse and support are shown in Table 1.

Table 1. Specifications of the YCB central fuse and support in case of the 12-story seesaw building

Curved Bars				Initial Stiffness (N.m/rad)	Yield Resistant (N.m)	Ultimate Resistant (N.m)
Number		Diameter (cm)				
upper	lower	upper	lower			
16	16	5	10	8.25E9	7.24E6	1.84E7

All considered buildings have a 4-bay square plan with bay span size of 5 m. For nonlinear time history analysis (NLTHA) of buildings several three-component accelerograms of a set of selected earthquakes were used. In addition to using a YCB device as the central fuse and support in each one of the multi-story seesaw buildings, a series of energy dissipating device similar to YCB, but acting in axial direction of columns were considered for all circumferential columns of all seesaw buildings to give them more energy dissipation capacity. A sample of these circumferential YCB (CYCB) devices along with its hysteretic force – displacement curves are shown in Figure 4.



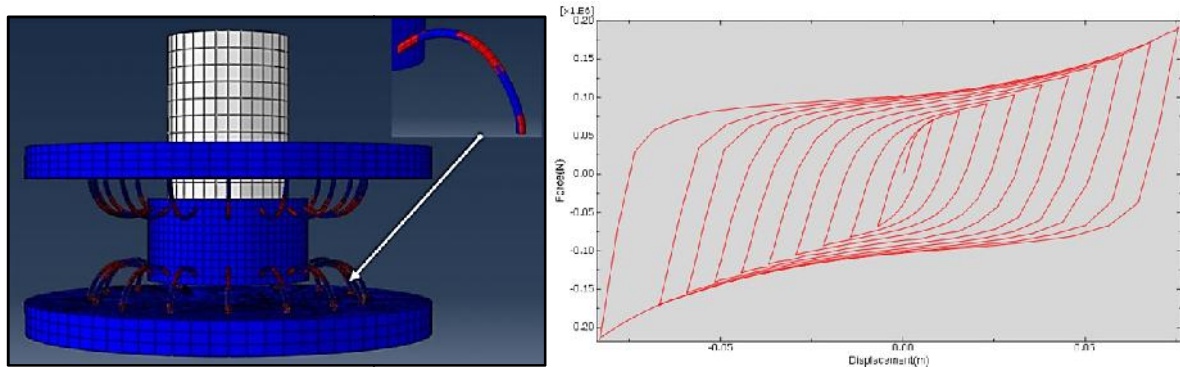

Figure 4. A sample of CYCB devices and its hysteretic force – displacement loops

The 12-story seesaw building equipped with YCB and CYCBs is shown in Figure 5, in which the strong structure at the lowest story of the building, carrying the loads of upper stories and transferring them to the central and circumferential supports via the YCB and CYCBs, is also shown.

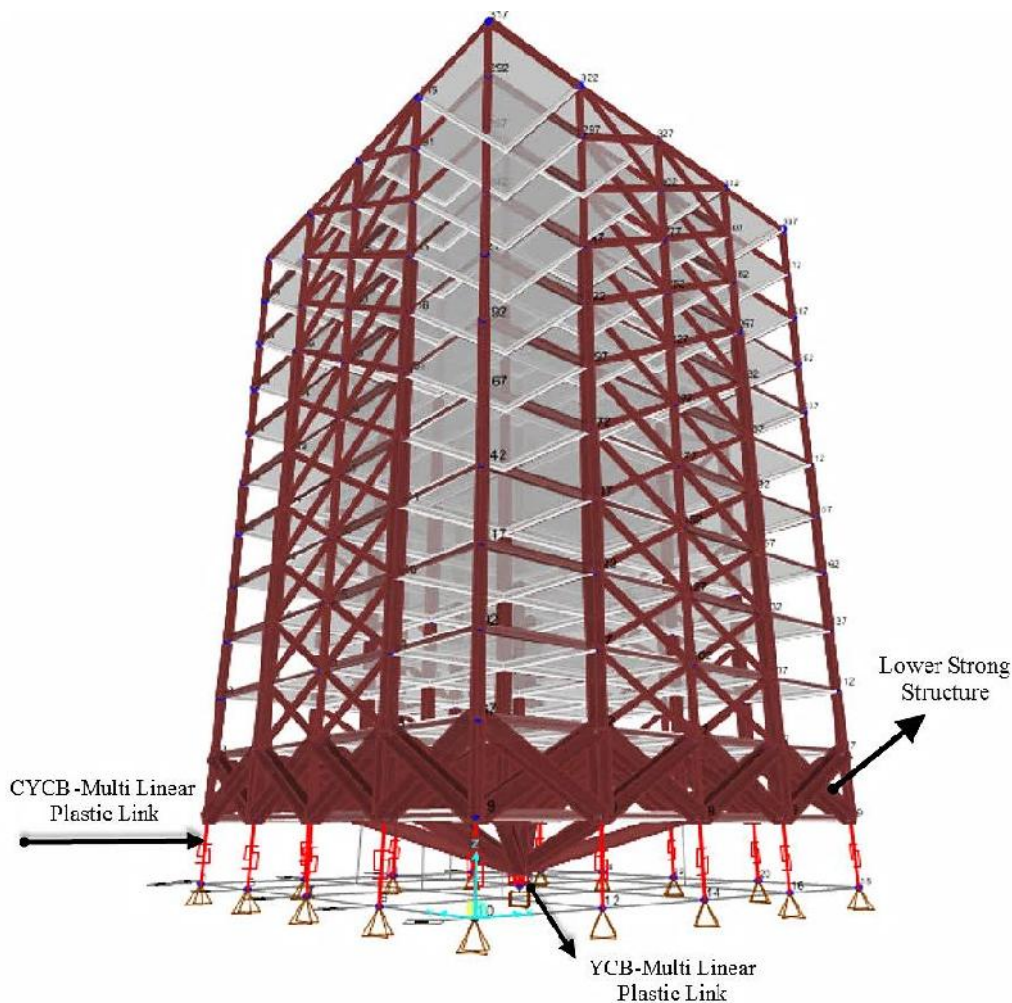

Figure 5. The 12-story seesaw building with YCB and CYCB devices and the strong structure at the lowest story

Theseismic responses which were obtained by NLTHA of both conventional and seesaw buildings include roof accelerations and displacement histories, maximum story drift ratios, plastic hinges formed in the building structure during the applied earthquakes, and hysteresis of both YCB and CYCB devices. It should be noted that the values of natural fundamental period of the conventional 12-story building is 2.11 sec, while that of the seesaw building is 2.76 sec, and this period elongation, which is due to the seesaw motion of the building's structure, leads to reduction of seismic response of the seesaw building in general. Furthermore, the high energy dissipation potential, created by YCB and CYCB devices at the lowest level help the upper stories to remain basically elastic. Figures 6 to 11 show various seismic responses of the 12-story conventional and seesaw buildings for comparison.

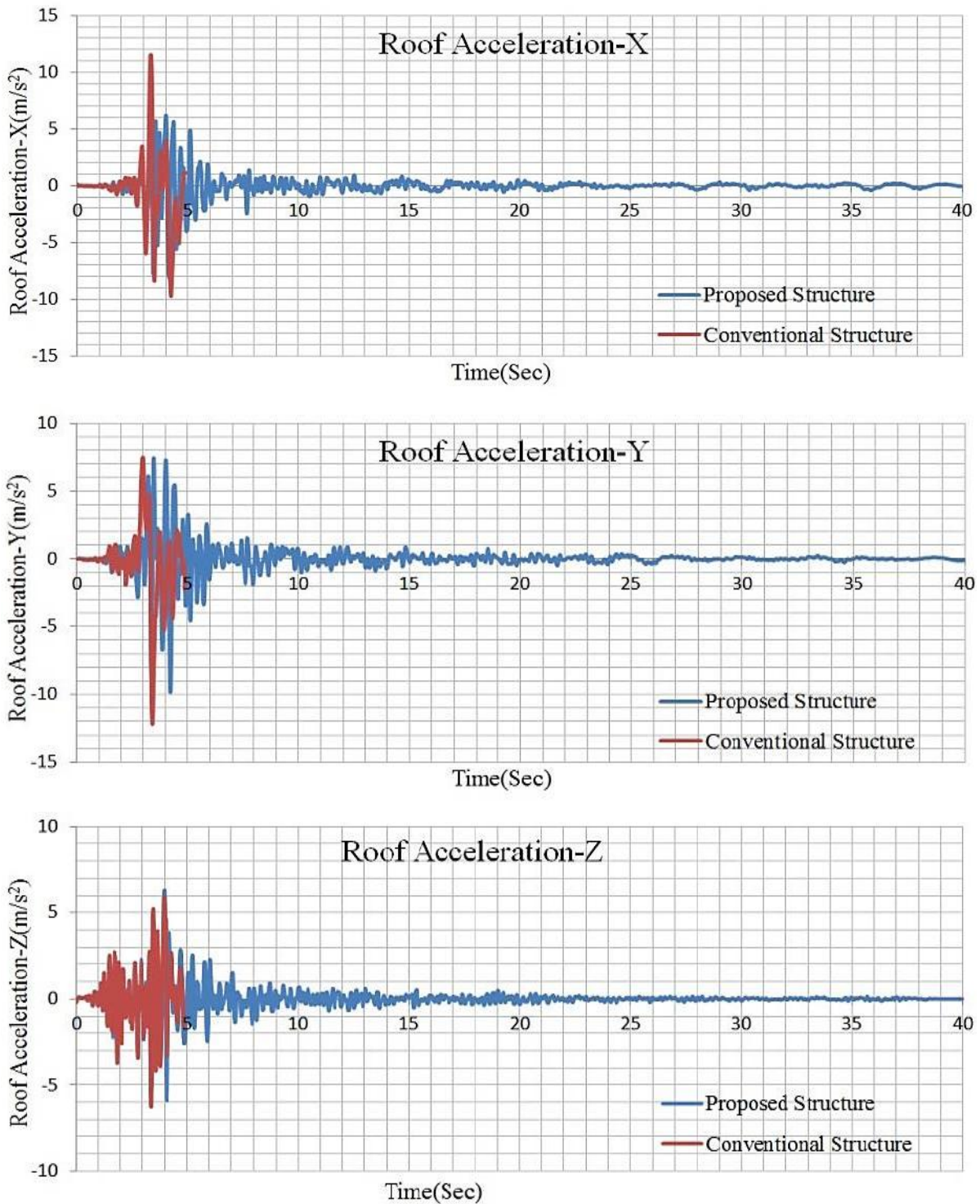

Figure 6. Roof acceleration histories of the 12-story buildings subjected to Loma Prieta earthquake

It is seen in Figure 6 that in case of the conventional building the analysis has stopped since the structural system of the building has not tolerated the earthquake excitation more than around five seconds, while in case of the seesaw building the analysis has continued till the end of earthquake.



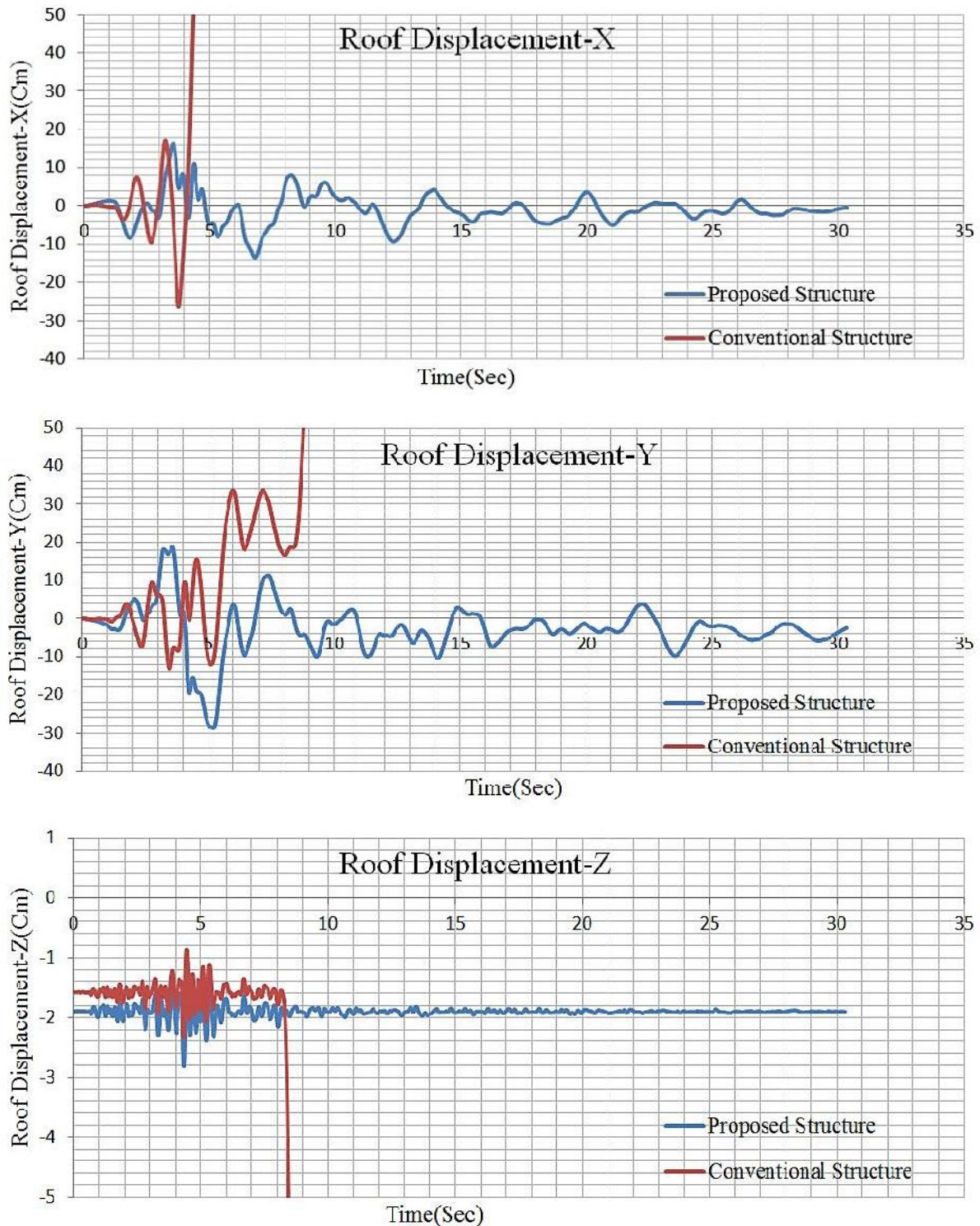

Figure 7. Roof displacement histories of the 12-story buildings subjected to Parkfield earthquake

The excessive movement of the conventional building during earthquake, due to instability, can be seen in Figure 7, while in case of the seesaw building maximum roof displacement has been less than 30 cm which is less than 1% of the building height. On this basis, it can be said that, contrary to the case of base isolated buildings which needs lots of room for their movement during earthquake, the seesaw building does not need room more than the code suggested space. The small difference between the roof displacement histories in Z direction at start, which is around 3 mm, is due to the different stiffness of the two systems in vertical direction. The high frequencies of the two buildings' structures in vertical direction can be also seen in the roof displacement histories in Z direction.



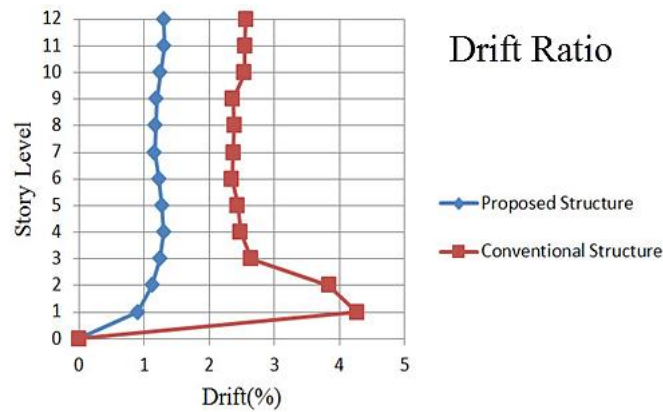

Figure 8. Drift ratios in the 12-story buildings subjected to Loma Prieta earthquake

It is seen in Figure 8 that the drift ratios are a little more than 1% and are almost the same in all stories of the seesaw building, while in case of the conventional building they are far beyond the code range.

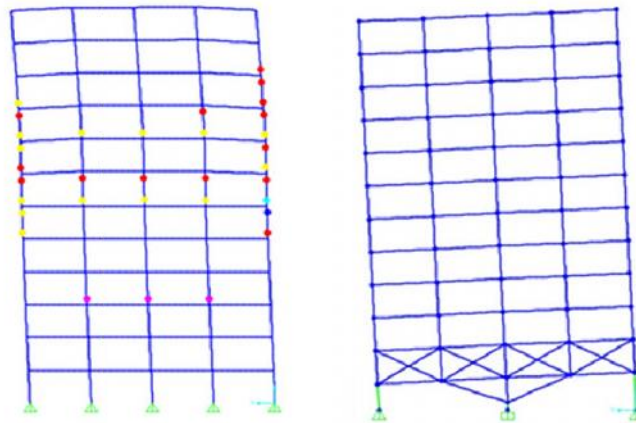

Figure 9. Plastic hinges formed in the conventional building (left) and the seesaw building (right) subjected to Northridge earthquake

Looking at the plastic hinge, shown in Figure 9, one can understand why in case of the conventional building the response history as not continued till the end of earthquake contrary to the seesaw building (Figures 6 and 7). As shown in Figure 9, several plastic hinges in beyond the collapse prevention performance level have been formed in many bracing elements as well as some columns.

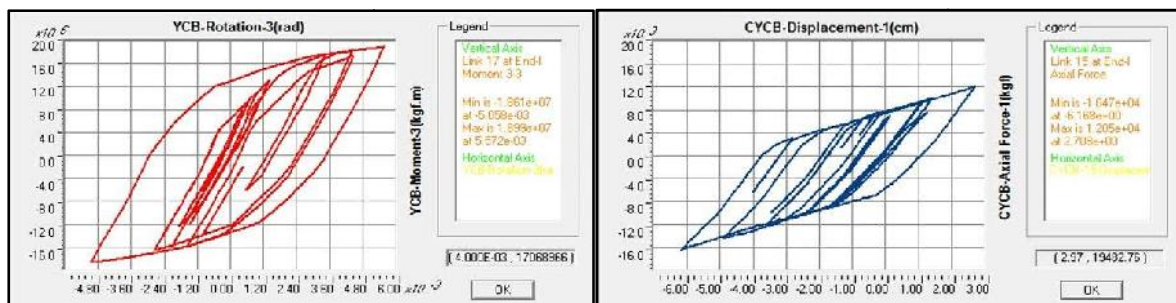

Figure 10. Samples of hysteresis loops of YCB and CYCB devices

The stable hysteresis loops of the YCB and CYCB devices can be seen in Figure 10. To make sure that performance of the CYCB links at either sides of the seesaw building is consistent with the motion of the building, the axial force histories of two of CYCBs locating at opposite points at either sides of the building are shown in Figure 11.

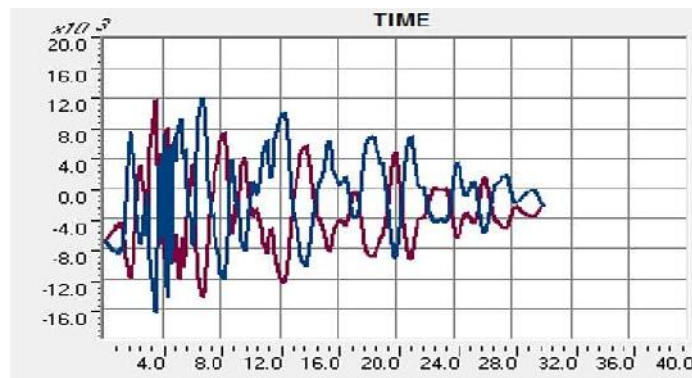

Figure 11. Axial force histories (in kgf) of the CYCB devices at opposite sides of the 12-story seesaw building subjected to Parkfield earthquake

As it is seen in Figure 11, the axial force history of both of the CYCB devices starts from the same value, which is around 6500 kgf compression, and they continue in an opposite manner till the end of the earthquake.

## CONCLUSIONS

- The suggested structural system with seesaw motion, based on using YCB and CYCB energy dissipaters, leads to much more reliable seismic behavior of buildings comparing to the conventional systems.
- The amount of drifts in the proposed seesaw buildings is generally less than the code allowable drifts, so that the building structural elements remain basically elastic, and the building structure can be easily repaired after a major earthquake by only replacing the heavily damaged bars of the YCB and CYCB devices.
- The maximum roof acceleration in seesaw buildings is around 60% of that in their conventional counterparts, which means more safety of nonstructural elements in seesaw buildings.

Finally it should be noted that to complete this study on buildings with seesaw motion, it is necessary to conduct some experimental studies as well.

## REFERENCES

- Azuhata T, Midorikawa M and Ishihara T (2004) Earthquake Damage Reduction of Buildings by Self-Centering Systems Using Rocking Mechanism, Proceedings of the 14<sup>th</sup> World Conference on Earthquake Engineering, Beijing, China
- Ghorbani Amirabad N (2015) Suggesting a few kinds of central fuse for buildings with rocking motion during earthquake, and comparing their behavior using finite element software (in Persian), M.Sc. thesis under supervision of Prof. Mahmood Hosseini, submitted to Civil Eng. Dept. of South Tehran Branch of Islamic Azad University, Tehran, Iran
- Hosseini M and Noroozinejad Farsangi E (2012) Seismic Behavior and Performance of Telescopic Columns as a New Base Isolation System for Vibration Control of Multi-Story Buildings, *International Journal of Earthquakes and Structures*, Vol. 3, No. 3
- Hosseini M and Kherad S (2013) A Multi-Stud Energy Dissipating Device as the Central Fuse to Be Used in Short- to Mid-Rise Regular Steel Buildings with Rocking Motion, Proceedings of the International Van Earthquake Symposium, Van, Turkey
- Hosseini Mand Alavi S (2014) A Kind of Repairable Steel Buildings for Seismic Regions Based on Building's Rocking Motion and Energy Dissipation at Base Level, *International Journal of Civil and Structural Engineering (IJCSE)*, Vol. 1, Issue 3, pp157-163

